

# Comparative Measurement

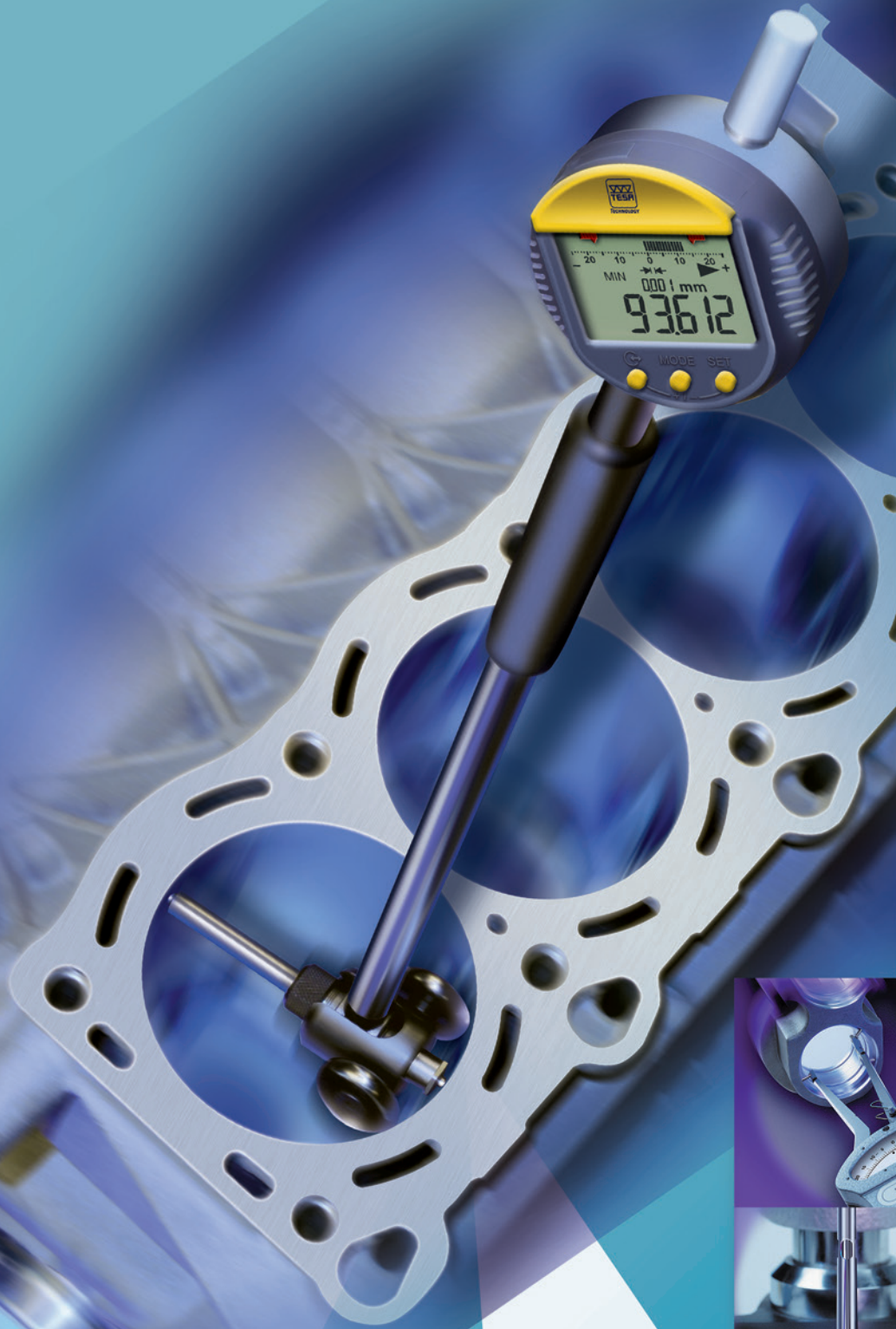

### TESA TPS - Motorised setting benches

The TPS are designed for setting hand-held measuring instruments and replace a complete set of ring gauges.

The setting bench is typically used with comparative measuring instruments such as dial gauges, lever-type dial test indicators or 2-point bore gauges.

TPS is very simple to use: enter the value and the mobile slide will automatically position itself at this value.

It can be used for checking internal as well as external dimensions of up to 1000 mm, according to the model.

Special adapters help to position the instrument, so that is very easy and quick to use and human errors can be avoided.

For versions with dimensions over 1000 mm, please contact TESA.

- 0,001 mm
- Linear 1,5 + L (mm) / 300 µm
- 1 µm
- 100/240 AC – 1,5 A 50/60 Hz
- Inspection report
- RS232
- Holding force 240 N



TESA TPS 500 + 02160027 + 02160024 (+ DIGICO 705)

No	=				
		Internal, mm	External, mm	mm	Kg
02130001	TESA TPS 300	0,1 ÷ 300	40 ÷ 340	610 x 300 x 270	75
02130002	TESA TPS 500	0,1 ÷ 500	40 ÷ 540	820 x 300 x 300	90
02130003	TESA TPS 1000	0,1 ÷ 1000	40 ÷ 1040	1330 x 340 x 340	240

CONSISTING OF:

02160038	Power supply 80 ÷ 240 V, 50 ÷ 60 Hz
02160027	Mobile stop adapter

The maximum permissible errors indicated for a metrological characteristic (MPE) have been obtained at a temperature of 20° ± 0,5°C and relative humidity of 50 ± 5 %.

### Accessories for Bore Gauges

Accessories for TESA VERIBOR bore gauges with round foot are available for different application ranges of up to 50 mm.

They offer a perfect setting by blocking the X and Z axis' rotating movements to let only the Y axis moving to find the min. point.

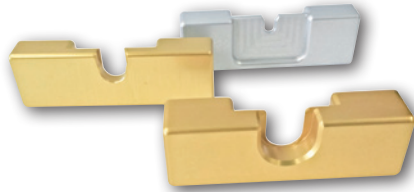
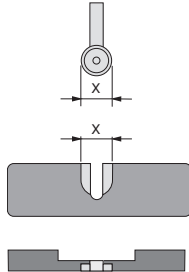

02160021 + TESA VERIBOR

No	mm	X, mm
02160020	4,5 ÷ 6	Ø 4,5
02160021	6 ÷ 12,5	Ø 5,8
S21050003	12 ÷ 25	Ø 9,5
02160023	25 ÷ 50	Ø 17,5

### Accessories for Bore Gauge

Accessories for TESA VERIBOR bore gauges with rectangular foot are available for different application ranges from 50 mm up to 550 mm.

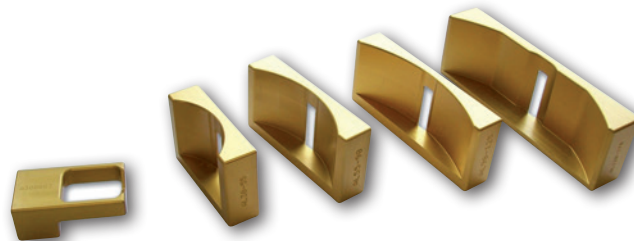
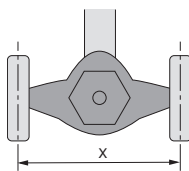

02160027

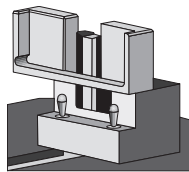

02160024

No	mm	X, mm
02160024	50 ÷ 150	30 ÷ 55
02160025	150 ÷ 300	55 ÷ 90
02160026	240 ÷ 550	90 ÷ 125
02160043		120 ÷ 170
02160044		170 ÷ 220

Each TESA TPS bench is delivered with an adapter No. 02160027



02160027 + 02160024 + TESA VERIBOR



### Accessory for External Micrometers

Set of accessories that allow horizontal alignment of the 2 measuring faces of the external micrometer.

Application range up to 150 mm = 1 piece required

Application range from 150 mm = 2 pieces required

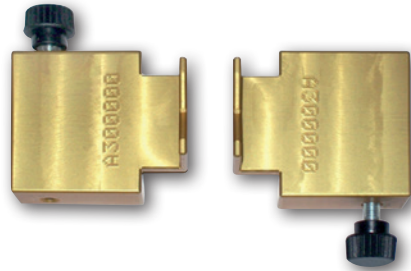

02160029

	
	mm
02160029	40 ÷ 300 / 500 / 1000

Delivered individually



02160029 + TESA MICROMASTER

### Accessory for TESA YA Bore Gauges

TESA YA bore gauges accessory is an assembly of few parts that accept all measuring ranges and make the min. point much easier to find.

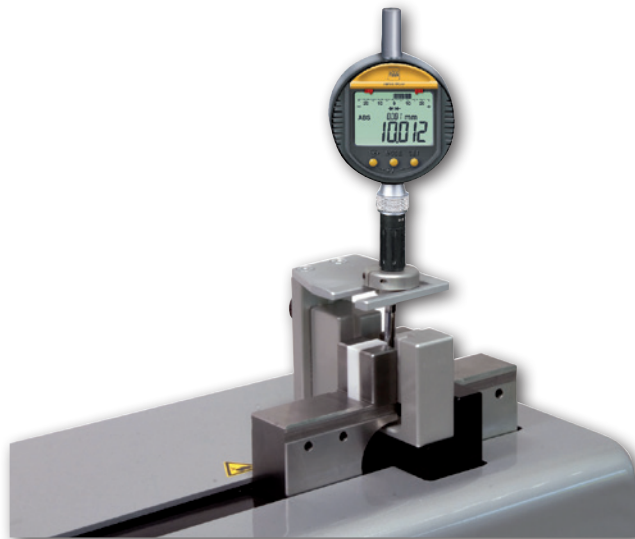

	
	mm
02160028	6 ÷ 12,5

Delivered with 3 adapter rings for Ø 8, 10 et 14 mm

02160028 + TESA DIGICO

## Accessories for Dial Gauges

A composition of 2 parts for fixing dial gauges on the fixed part of the bench.

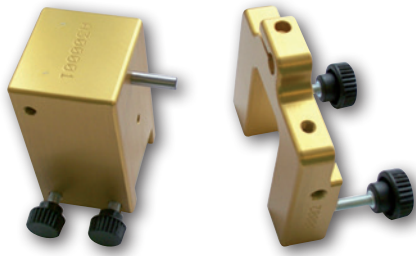

02160035

	
	mm
02160035	10 ÷ 150

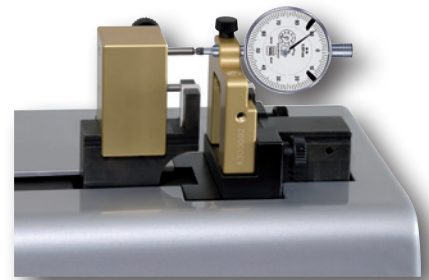

## Accessory for Internal Arm Comparator

Set of accessories for horizontal alignment of the 2 measuring points, 2 items required.



02160030

	
	mm
02160030	10 ÷ 150

Delivered individually

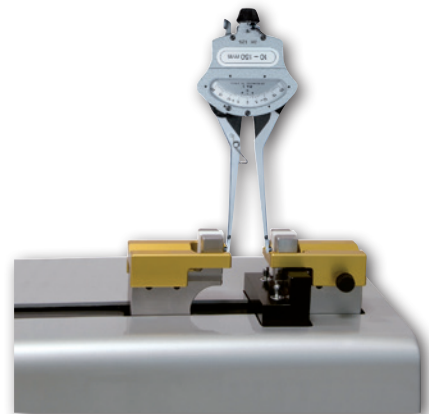

02160030 + TESA IRA 2



## TESA YA COMPLETE INSTRUMENT SETS

Specially designed for small bores from 0,47 up to 12,20 mm - Checking of dimension and bore form errors through 2-point measuring - Offers an excellent repeatability. The YA bore gauges consist of an interchangeable measuring head with a built-in needle and handle with a 8 mm diameter fixing bore for a dial gauge or any other type of sensor

- Measuring heads with spherical faces for through bores.
- Measuring heads for particularly deep bores.

Can be supplied on request:

- Measuring heads with carbide measuring faces.
- Measuring heads for special applications.
- Measuring heads for blind bores and particularly deep bores with other application ranges.
- Carbide measuring needles.
- Depth extensions 125, 250, 500, 750 and 1000 mm.

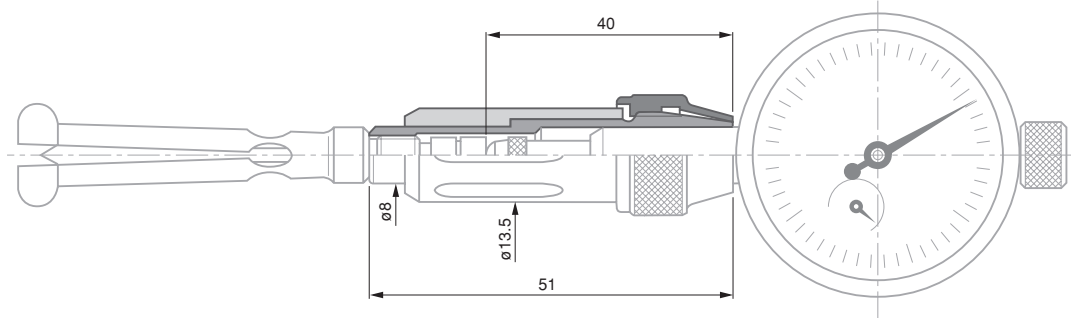
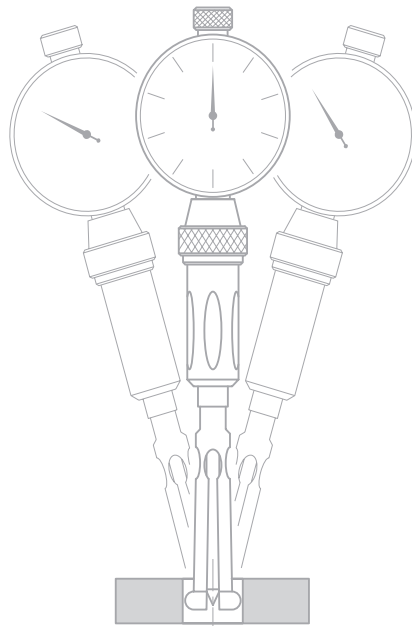

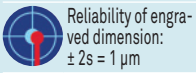
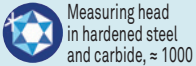
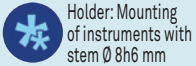

1 µm

Reliability of engraved dimension:  
± 2s = 1 µmMeasuring head in hardened steel and carbide, ≈ 1000 HV 25  
Measuring needles in hardened steel, ≈ 800 HV 25  
Setting rings: with synthetic sapphire for nominal  $\varnothing \leq 1,5$  mm and hardened steel for  $> 1,5$  mm, ≈ 780 HV 25Holder: Mounting of instruments with stem  $\varnothing 8h6$  mmComplete set includes:  
1 handle No. 01540201.  
Measuring heads, needles and setting rings as shown in the table below.  
1 TESA YR 01410212 dial gauge (reading to 0,01 mm,  $\varnothing 40$  mm dial)  
1 Extension for for inserts, 10 mm No. 03540501.

## COMPLETE INSTRUMENT SETS FOR MEASURING THROUGH BORES







No



mm

01510000	0,47 ÷ 0,97
01510100	0,95 ÷ 2,45
01510200	2,30 ÷ 6,20
01510300	6,00 ÷ 12,20

	No				No	No		
	Measuring heads	mm	Measuring depth max. mm	Measuring depth min. mm	Needles	Setting rings mm		
<b>COMPOSITION OF THE SETS:</b>								
<b>01510000</b>	01540401	0,47 ÷ 0,53	1,5	0,25	01540001	01540601	0,50	
	01540402	0,52 ÷ 0,58	1,8	0,27	01540001	01540602	0,55	
	01540403	0,57 ÷ 0,67	2,0	0,29	01540002	01540603	0,60	
	01540404	0,65 ÷ 0,77	2,5	0,31	01540002	01540604	0,70	
	01540405	0,75 ÷ 0,87	2,8	0,33	01540002	01540605	0,80	
	01540406	0,85 ÷ 0,97	3,0	0,35	01540002	01540606	0,90	
	<b>01510100</b>	01540407	0,95 ÷ 1,15	11	0,6	01540003	01540607	1,00
		01540408	1,07 ÷ 1,25	11	0,6	01540003	01540608	1,10
		01540409	1,17 ÷ 1,35	11	0,6	01540003	01540609	1,20
		01540410	1,27 ÷ 1,45	11	0,6	01540003	01540610	1,30
		01540411	1,37 ÷ 1,55	11	0,6	01540003	01540611	1,40
		01540412	1,50 ÷ 1,90	17	0,9	01540004	01540612	1,50
		01540413	1,70 ÷ 2,15	17	0,9	01540004	01540613	1,75
		01540414	2,05 ÷ 2,45	17	0,9	01540004	01540614	2,00
					01540615	2,25		
<b>01510200</b>	01540415	2,30 ÷ 2,75	22	1,2	01540005	01540616	2,50	
	01540416	2,65 ÷ 3,20	22	1,2	01540005	01540617	3,00	
	01540417	3,05 ÷ 3,50	22	1,2	01540005	01540618	3,25	
	01540418	3,35 ÷ 3,85	22	1,2	01540005	01540619	3,50	
	01540419	3,80 ÷ 4,30	22	1,2	01540005	01540620	4,00	
	01540420	4,20 ÷ 5,00	40	2,0	01540006	01540621	4,50	
	01540421	4,70 ÷ 5,50	40	2,0	01540006	01540622	5,00	
	01540422	5,30 ÷ 6,20	40	2,0	01540006	01540623	5,75	
	<b>01510300</b>	01540423	6,00 ÷ 6,80	40	2,0	01540006	01540624	6,50
		01540424	6,60 ÷ 7,50	40	2,0	01540006	01540625	7,00
01540425		7,30 ÷ 8,15	40	2,0	01540006	01540626	7,75	
01540426		8,00 ÷ 8,80	40	2,0	01540006	01540627	8,50	
01540427		8,50 ÷ 9,40	50	2,0	01540006	01540628	9,00	
01540428		9,15 ÷ 10,00	50	2,0	01540006	01540629	9,50	
01540429		9,60 ÷ 10,80	50	3,3	01540007	01540630	10,00	
01540430		10,65 ÷ 12,20	50	3,3	01540007	01540631	11,50	



## Special Executions

Available upon request :

- Full instrument sets for measuring blind bores and short centering shoulders.
- Measuring heads with tungsten carbide tipped measuring faces.
- Measuring heads for special applications.
- Measuring heads for through bores, particularly deeper ones covering other application ranges.
- Tungsten carbide measuring needles.
- 125, 250, 500, 750 and 1000 mm depth extensions.

## Optional Accessories for TESA YA Bore Gauges

Measuring stand for stationary use.



01639009 INTERAPID UA 30 Support

*MUST BE EQUIPPED WITH:*

01610201 UK 25 sliding arm.  
Used with TESA YA for stationary bore measurement on UA30 support.

01640000 UAZ 10 depth stop plate for UA 30



## TESA VERIBOR

Proven design and reliability never questioned over decades – Instruments for 2-point measurements for bores from 4,5 up to 550 mm – Detects form errors – Gauge body with a 8 mm diameter clamping bore for a dial gauge, precision indicator or any other sensor.

- Excellent repeatability due to the circular element fixed on the instrument ensuring practically no play.
- Gauge body made of invar steel to neutralise the influence of the operator's hand warmth on the measuring result.
- Centring shoe for correct alignment of the instrument in the bore.
- Tungsten carbide ball tips for high resistance to wear.

## TESA VERIBOR Light

Instrument with 2 contact points for comparative measurement of bores and detection of form errors – Automatic self-centering in the bore – Can be used with a dial gauge, a precision indicator or a probe with  $\varnothing 8h6$  clamping stem.



4 µm



2 µm

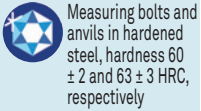

Measuring bolts and anvils in hardened steel, hardness  $60 \pm 2$  and  $63 \pm 3$  HRC, respectively

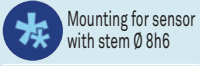

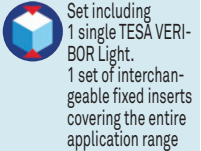

Mounting for sensor with stem  $\varnothing 8h6$



Set including 1 single TESA VERIBOR Light. 1 set of interchangeable fixed inserts covering the entire application range







No	=			
		Measuring bolt travel, mm	mm	Measuring depth, mm
05710090	TESA VERIBOR light	1,30	18 ÷ 35	176
05710091	TESA VERIBOR light	1,40	35 ÷ 60	178
05710092	TESA VERIBOR light	1,40	50 ÷ 150	178
05710093	TESA VERIBOR light	1,30 / 1,40	18 ÷ 150	176 / 178

Sets delivered without dial gauge



## TESA VERIBOR



-  Only VERIBOR without dial gauge: 2 μm
-  Only VERIBOR without dial gauge: ± 2s = 0,5 μm
-  Measuring bolts and anvils fitted with carbide ball tips
-  Mounting for sensor with stem Ø 8 h6 mm
-  Set including 1 single TESA VERIBOR. 1 set of interchangeable fixed inserts covering the whole application range.

No	mm
05710012	4,5 ÷ 6
05710013	6 ÷ 12,5
05710014	12 ÷ 25
05710015	25 ÷ 50
05710016	50 ÷ 150
05710018	50 ÷ 300
05710017	240 ÷ 550

Sets supplied without dial gauges, electronic probes or indicators

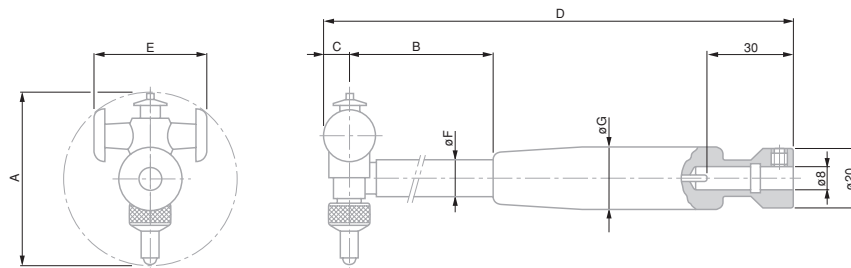

A mm	mm	B mm	C mm	D mm	E mm	F mm	G mm
4,5 ÷ 6	0,35	74	2	138	3,3	3,8	16
6 ÷ 12,5	0,5	93	2,6	156	4,3	4,9	16
12 ÷ 25	0,9	106	4,5	194	7,8	7,9	19
25 ÷ 50	1,3	140	6	228	16	8	19
50 ÷ 150	1,4	173	10	279	36	12	23
50 ÷ 300	1,4	173	10	279	36 / 66	12	23
240 ÷ 550	1,6	227	14	347	112	18	28

### Special Versions

Available on request :

- TESA VERIBOR for blind bores and centring shoulders.
- TESA VERIBOR elbow-shaped for hard-to-reach bores.
- Handtools for measuring the distance between two plan-parallel surfaces.
- Handtools for inspecting gear pitch diameters.

## ACCESSORIES FOR TESA VERIBOR

### Set of Extensions

For extending the application range to  $\varnothing$  300 mm for VERIBOR No. 05710016.

No	=	Consisting of
05740001	Set of extensions	- 1 Centring shoe - 3 Extensions 50 mm



### Depth Extensions

To be mounted on the body of VERIBOR  $\varnothing \geq 25 \leq 550$  mm for large measuring depths (dimension B in the technical drawing of the VERIBOR).

No	=	mm
05760029	Extension	1000
05760027	Extension	500



### Dial Gauge Protection Guard

Protects the dial gauge against direct shocks and prevents the dial from being inadvertently rotated.

No	=	mm
05760013	Protection guard	$\varnothing$ 58



## ARM GAUGES

Very practical comparative measuring instrument – Measures at 2 or 3 points depending on the accessory used – Ideal for blind or through bores – also suited for measuring grooves, flutes as well as the internal measurement of parts with parallel faces.

### IRA 2 Comparative Gauge

- Large application range from 10 to 150 mm
- Easy to handle thanks to its light weight and ergonomic design
- Built-in indicator with 0,01 mm reading and fine setting
- Centering device for 2-point measurement

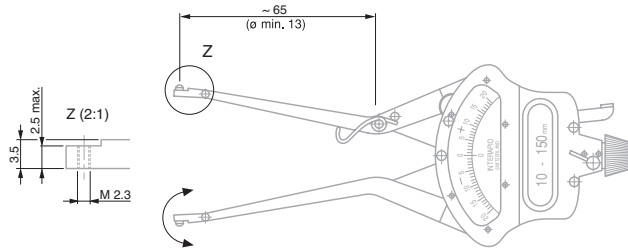
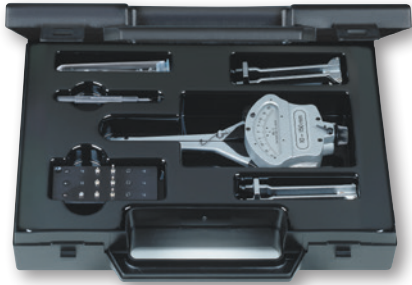

No	=	A
079105704	INTERAPID IRA 2	mm
079111401	INTERAPID IRA 2, carbide	mm
<b>DELIVERED WITH THE FOLLOWING ACCESSORIES:</b>		
079105667	3 inserts, hardened steel (order number for 1 unit, with 079105704)	
079105756	3 inserts, carbide (order number for 1 unit, with 079111401)	
079105668	3 short inserts, hardened steel (order number for 1 unit)	
079105669	3 long inserts in hardened steel (order number for 1 unit)	
079112126	2 inserts, adjustable for internal dia. >6mm	
079110110	Large insert holder for 3-point measurement	
079108502	IRA centering arm, Ø 15-30 mm	
079110111	Small insert holder for 3-point measurement	
079105694	Special screwdriver for IRA set	

### Optional Accessories for IRA-2 Comparative Gauge

No	=
079112051	Small insert set for 3-point measurement
079112052	Long insert set pour 3-point measuring

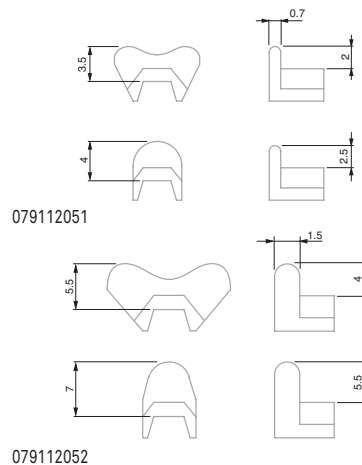
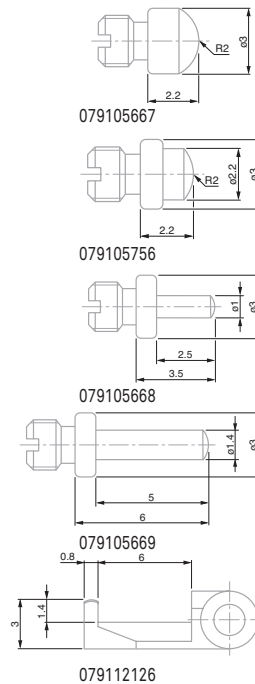
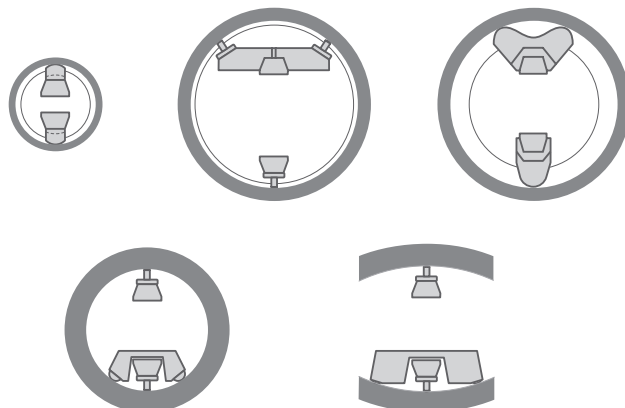

- ± 0,20 mm or ± 0,008 in
- 10 ÷ 150 mm 0.375 ÷ 6 in
- 0,01 mm or 0.0005 in
- Measuring inserts in hardened steel or tungsten carbide, see opposite table
- 3,5 N
- Measuring arm clearance travel: 10 mm



Chrome plated, hardened steel

Ø 57 mm

0,2 mm

Dial gauge: 5 µm

30 mm throat depth.  
Highly stable frame with heat insulating handle.

≈ 2 N

Non-interchangeable measuring inserts. With device for retraction of inserts.

## THICKNESS GAUGES

Designed for the direct measurement of thickness of all types of materials: plastics, glass, wood, felt, paper, rubber, etc.

Each gauge is equipped with a rotating dial for zero setting.

### Model for Sheets



074115664	Thickness gauge for sheets	mm 0 ÷ 1	mm 0,001	Flat, mm Ø 6,35

Ø 57 mm

10 mm

Dial gauge: 40 µm

Interchangeable measuring inserts

### Models with Open Inserts When Not in Use



074115604	0 ÷ 30	0,1	50	flat; Ø 30	074115686
074115605	0 ÷ 30	0,1	50	flat; Ø 20	074115687
074115606	0 ÷ 30	0,1	50	flat; Ø 10	074115726
074115607	0 ÷ 30	0,1	50	convex; Ø 10	074115727
074115608	0 ÷ 30	0,1	50	spherical; Ø 5	074115728



## INTERAPID SHE.30 & SHE.35 SMALL HORIZONTAL MEASURING BENCHES

Extremely practical and very precise, these measuring benches are mainly used for the inspection of batches of precision parts as used in the watch making and precision mechanical sectors – Rapid measuring and easy setting from one part to the other – Wide choice of measuring inserts specially designed for the most varied of metrology applications.

### INTERAPID SHE.30 for External Dimensions

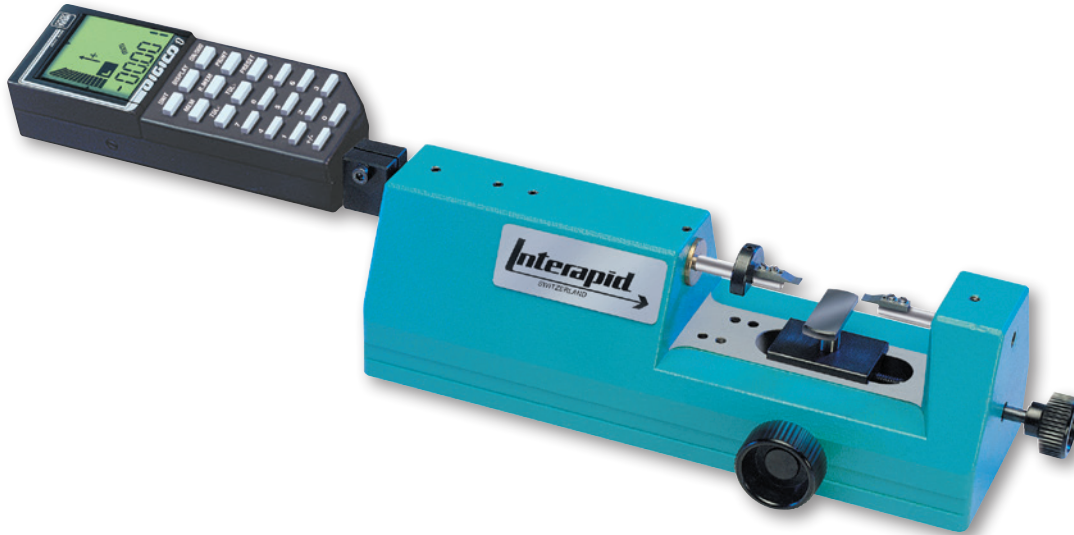

0 to 30 mm



Accuracy is usually influenced by the measuring instrument used as well as both flatness and parallelism of the measuring faces of inserts.  
Holder precision: Flatness tolerance of two clamping faces: 0,05 mm. Axial positioning tolerance for the two indexing pins with respect to bolt axis: 0,05 mm. Tolerance for the parallelism of the table surface with respect to the bolt axis: 0,05 mm. See drawing



Main body in cast iron. Other parts in steel, hardened and ground



Produced by sensor used. The SHE.30 model is not spring-loaded.



Mobile measuring bolt: guided on a smooth bearing surface and equipped with a semi-circular disc for bolt retraction. Measuring inserts, assembled in pairs, and mounted on the measuring bolt and fixed anvil with a 1 mm diameter pin and 2 M1,4 screws. Support table with possibility of vertical and longitudinal adjustment: Surface 24 x 9,5 mm. Adjustment range: vertical: 15 mm, longitudinal: 14 mm. With fixing screw. Sensor (not included in the supply for SHE 30 bench): electronic indicator, mechanical or precision dial gauge, axial analogue or digital probe with mounting shank of Ø 8 mm



2,1 kg



**03330004** INTERAPID SHE 30 small measuring horizontal bench for external dimensions (without measuring inserts)

**OPTIONAL ACCESSORY:**

**03360300** Measuring inserts, carbide, length 3,5 mm, height 0,4 mm

Measuring inserts, either cylindrical or knife-edged are available on request.

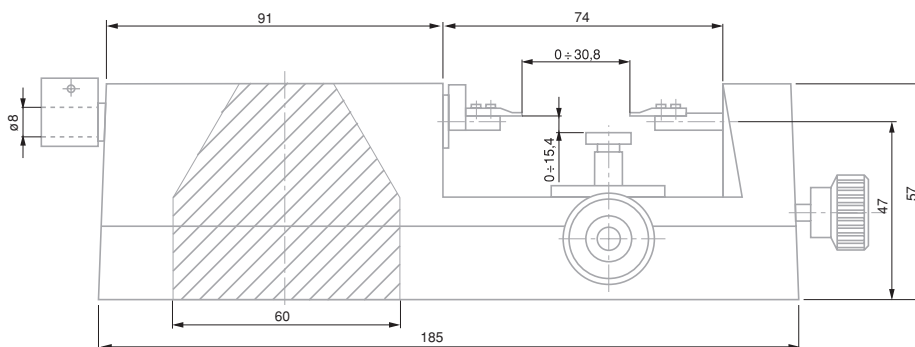

### Pair of Measuring Inserts in Special Version

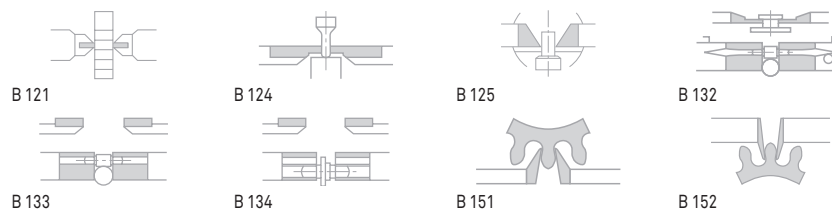

## INTERAPID SHE.35 for Internal Dimensions



30 mm



8 to 38 mm (standard accessory)

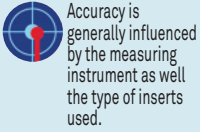

Accuracy is generally influenced by the measuring instrument as well as the type of inserts used.



Main body in cast iron. Other parts in hardened and ground steel. Inserts with carbide measuring faces.



Produced by sensor used. The SHE.35 bench is not equipped with a spring.

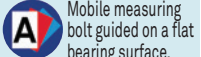

Mobile measuring bolt guided on a flat bearing surface, also fitted with a retracting ball-shaped handle. Interchangeable measuring inserts supplied in pairs. Fixing shaft  $\varnothing$  4 mm. Height adjustable support table. Surface: 40 x 70 mm. Setting range: 8 mm. 1 tightening screw. Sensor (must be ordered separately), e.g. dial gauge, electronic or precision indicator, analogue or digital probe. Mounting  $\varnothing$  8 mm.



2,3 kg



**03330006** INTERAPID SHE 35 small horizontal measuring bench for internal dimensions (with measuring inserts)

8 ÷ 38 mm

Inserts with special design also available on request

